



US009021722B2

(12) **United States Patent**
Kasprzak

(10) **Patent No.:** **US 9,021,722 B2**

(45) **Date of Patent:** ***May 5, 2015**

(54) **SOLE FOR A GOLF SHOE**

(71) Applicant: **ECCO Sko A/S**, Bredebro (DK)

(72) Inventor: **Dieter Kasprzak**, Bredebro (DK)

(73) Assignee: **ECCO Sko A/S**, Bredebro (DK)

(*) Notice: Subject to any disclaimer, the term of this patent is extended or adjusted under 35 U.S.C. 154(b) by 0 days.

This patent is subject to a terminal disclaimer.

(21) Appl. No.: **13/867,288**

(22) Filed: **Apr. 22, 2013**

(65) **Prior Publication Data**

US 2013/0232823 A1 Sep. 12, 2013

Related U.S. Application Data

(60) Division of application No. 13/357,131, filed on Jan. 24, 2012, which is a continuation of application No. 12/874,285, filed on Sep. 2, 2010, now Pat. No. 8,490,303.

(30) **Foreign Application Priority Data**

Apr. 14, 2010 (EP) 001695073
Apr. 16, 2010 (EP) 001696550

(51) **Int. Cl.**
A43B 5/00 (2006.01)
A43B 13/22 (2006.01)

(52) **U.S. Cl.**
CPC **A43B 5/001** (2013.01); **A43B 13/223** (2013.01)

(58) **Field of Classification Search**

CPC A42B 5/001; A42B 13/223
USPC 36/127, 67 A, 126, 128, 129, 134, 67 R,
36/67, 59 R, 59 C, 67 D; D2/954-959
See application file for complete search history.

(56) **References Cited**

U.S. PATENT DOCUMENTS

3,988,840	A *	11/1976	Minihane	36/32 R
4,085,527	A *	4/1978	Riggs	36/114
4,327,503	A *	5/1982	Johnson	36/32 R
D266,966	S *	11/1982	Inohara	D2/908
4,378,643	A *	4/1983	Johnson	36/129
4,402,145	A *	9/1983	Dassler	36/32 R
4,590,693	A *	5/1986	Kawashima et al.	36/126
4,782,604	A *	11/1988	Wen-Shown	36/127
D440,032	S *	4/2001	Madden	D2/954
D467,061	S *	12/2002	Della Valle	D2/954
D468,517	S *	1/2003	Recchi et al.	D2/954
D474,879	S *	5/2003	Nason	D2/955
D481,201	S *	10/2003	Shea et al.	D2/954
D500,190	S *	12/2004	Della Valle	D2/954
D509,950	S *	9/2005	Adams et al.	D2/959
7,146,752	B2 *	12/2006	Pasternak et al.	36/59 R
D560,888	S *	2/2008	Della Valle	D2/954
D597,735	S *	8/2009	Norton	D2/957
D599,990	S *	9/2009	Belley et al.	D2/952
D619,345	S *	7/2010	Favreau et al.	D2/957
D646,050	S *	10/2011	Norton	D2/957
2008/0201992	A1 *	8/2008	Avar et al.	36/25 R
2011/0247243	A1	10/2011	Eder et al.	

* cited by examiner

Primary Examiner — Ted Kavanaugh

(74) *Attorney, Agent, or Firm* — McCormick, Paulding & Huber LLP

(57) **ABSTRACT**

An outer sole for a golf shoe includes a plurality of cleats distributed along a forefoot area and a heel area. The cleats are integrated with the outer sole and extend from a surface of the outer sole that faces away from the shoe. The plurality of cleats includes at least a larger sized set of cleats and a smaller sized set of cleats. Such outer sole for a golf shoe gives good traction on the golf course but is also useable as a casual shoe off the golf course.

19 Claims, 3 Drawing Sheets

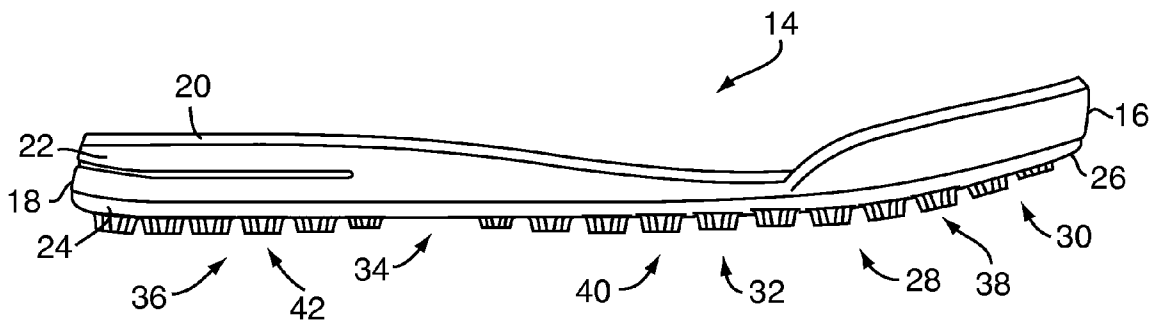

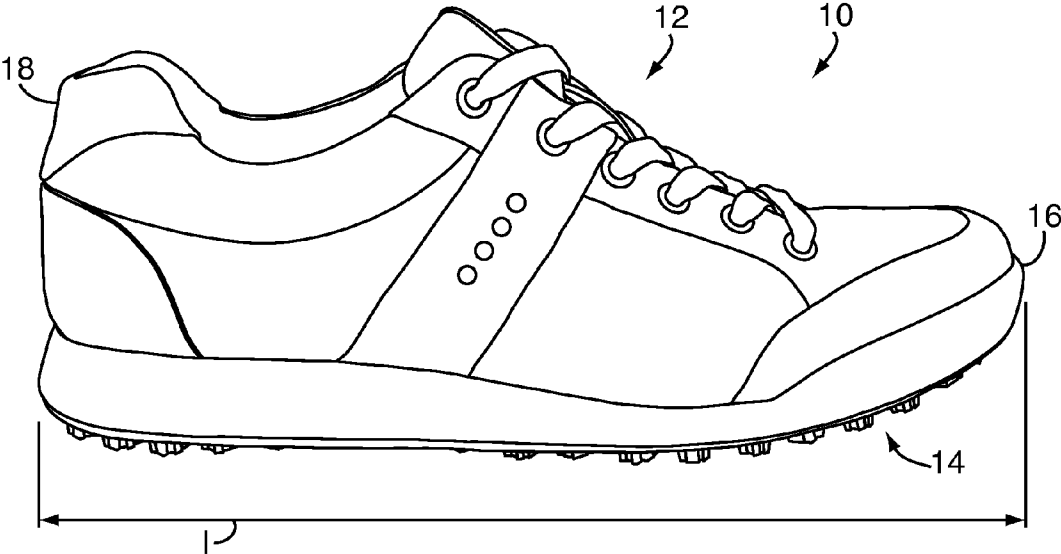

FIG. 1

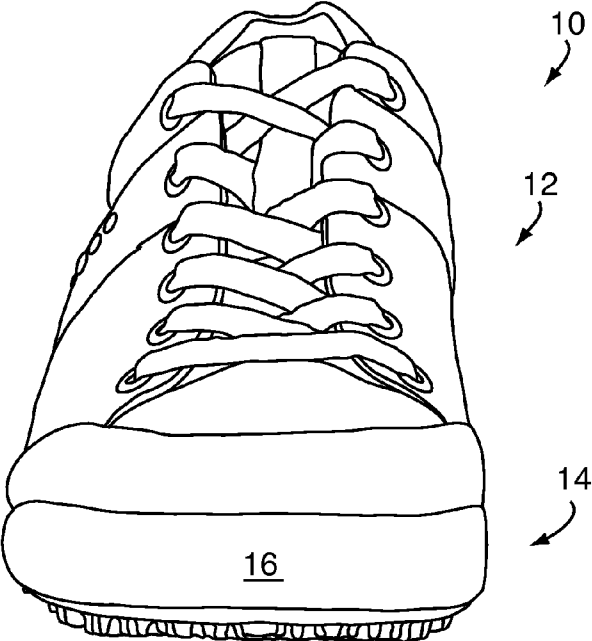

FIG. 2

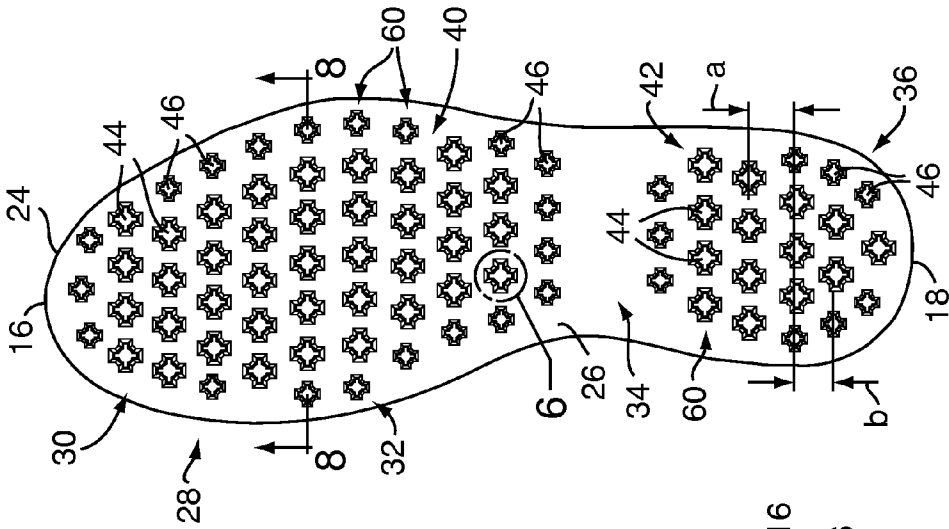

FIG. 3

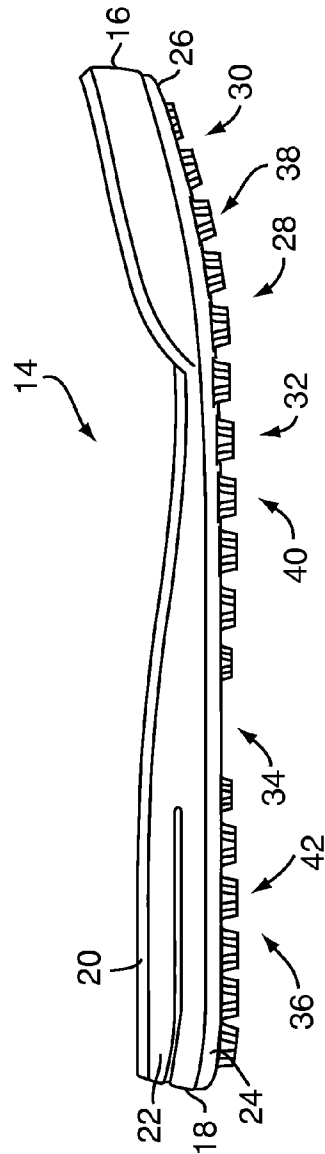

FIG. 4

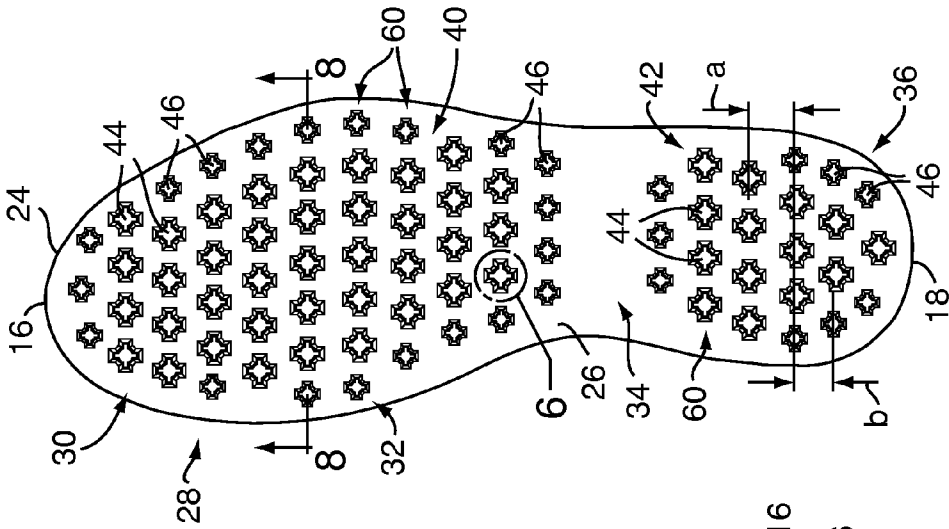

FIG. 5

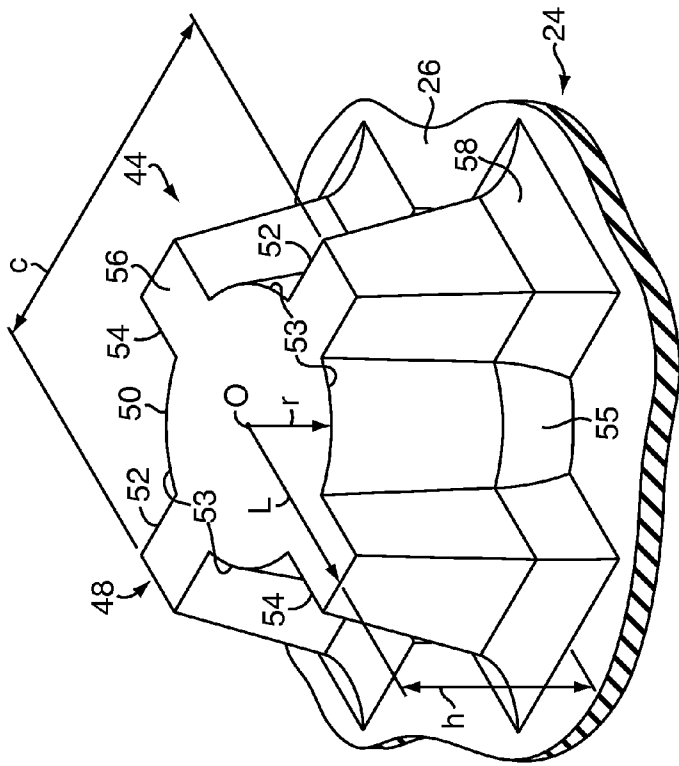

FIG. 7

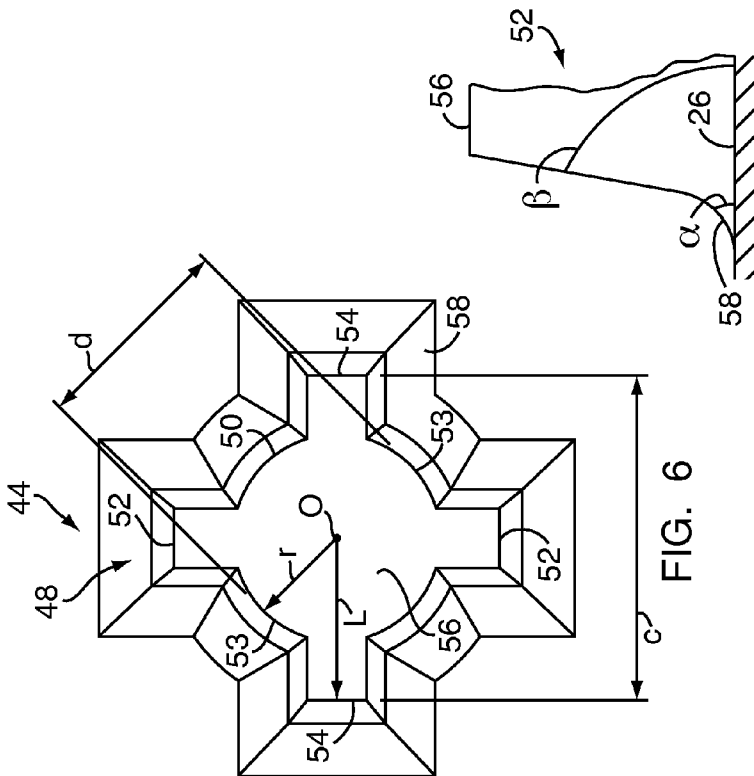

FIG. 6

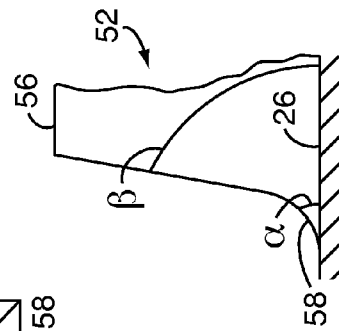

FIG. 8

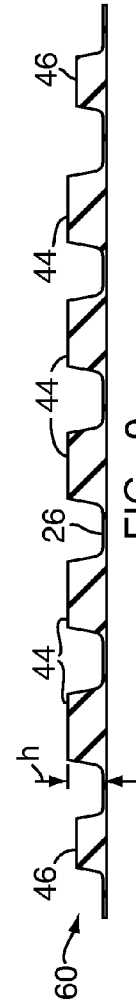

FIG. 9

SOLE FOR A GOLF SHOE

CROSS REFERENCE TO RELATED APPLICATIONS

This application is a divisional application of U.S. application Ser. No. 13/357,131, filed on Jan. 24, 2012, which is a continuation application of U.S. application Ser. No. 12/874,285, filed on Sep. 2, 2010, which is entitled to the benefit of European Design registration Nos. 001695073-001, filed Apr. 14, 2010, and 001696550-0026, filed Apr. 16, 2010, each of which is hereby incorporated by reference in its entirety. U.S. application Ser. No. 12/874,285 also incorporates by reference essential subject matter disclosed in a U.S. Design Application No. 29/370,153, filed Jun. 11, 2010, which is hereby also incorporated by reference in its entirety.

BACKGROUND OF THE INVENTION

1. Field of the Invention

The present invention relates to golf shoes and, more particularly, to a sole therefor.

2. Description of the Related Art

A golfer needs a strong grip or traction between a golf shoe and the green. The traction is particularly important during a golf swing. Existing golf shoes generally include protrusions on an outer sole to achieve the grip. The protrusions are typically called studs, spikes or cleats. In the following the word cleat will be used. Some golf shoes have soles with a receptacle into which the cleat is screwed. The cleat is thus removable and replaceable. Other golf shoes have the cleats integrally molded with the sole. An example of an athletic shoe with integrally molded cleats is described in U.S. Pat. No. 4,327,503.

A major problem with golf shoes with cleats is that the cleats can leave cleat marks (or holes) on a grass surface of a golf course, particularly on a putting green, therefore, damaging the green. A careless golfer who shuffles or twists his feet while walking across the putting green can damage the grass surface. Even a careful golfer can leave cleat marks on the putting green, particularly when the putting green is wet. Some golf clubs even ban golf shoes with steel cleats from the golf course because this type of cleats has long nails that damage the green. In order to avoid such damage but still have a firm grip, a special type of "soft cleats" or "soft spikes" has been developed during recent years. These cleats comprise between four and six resilient arms extending from a base; the arms resiliently dig into the green and create at the same time sufficient grip. A drawback is, however, that once the golf player leaves the course, the arms, which are typically made from plastic, are immediately exposed to wear and tear from e.g. the asphalt of the street. Use outside the golf course rapidly wears down the plastic arms, and the cleat has to be replaced with a new one.

Another problem with golf shoes with cleats is that the shoes tend to accumulate dirt and debris, especially during wet conditions. The accumulation of such dirt and debris requires frequent and tedious cleaning to provide the desired grip during the golf swing.

SUMMARY OF THE INVENTION

One object of the invention is to create a sole for use in a golf shoe which ensures a satisfactory grip without damaging the golf course. A further objective is to make a golf sole which is versatile and comfortable and can be used both inside and outside the golf course.

According to the present invention, a golf shoe includes an outer sole having a plurality of cleats distributed along a forefoot and a heel area. The cleats are disposed on and extend away from an outer surface of the outer sole. The cleats are essentially cross-shaped with a central circle to minimize sharp internal corners.

The forefoot of the outer sole has more cleats per area unit (e.g. per square inch) than the heel area of the outer sole. The forefoot includes a ball area and a toe area. The ball area and the heel area have cleats with greater heights and widths than other areas of the sole. The cleats along the ball area and the heel area are substantially equal in height. The cleats are arranged in transverse rows along a longitudinal length of the outer sole.

BRIEF DESCRIPTION OF THE DRAWINGS

FIG. 1 is a side view of a golf shoe according to the present invention;

FIG. 2 is a front view of the golf shoe of FIG. 1;

FIG. 3 is a perspective view of a sole of the golf shoe of FIGS. 1-2;

FIG. 4 is a side view of the sole of the golf shoe of FIG. 1;

FIG. 5 is a bottom view of the sole of the golf shoe of FIGS. 1-3, with a plurality of cleats;

FIG. 6 is an enlarged view of one of the cleats of FIG. 5;

FIG. 7 is a perspective view of the cleat of FIG. 6;

FIG. 8 is a partial cross sectional view of the cleat of FIG. 7; and

FIG. 9 is a section view of FIG. 4 taken along line 8-8 in the direction of a toe end of the shoe.

DESCRIPTION OF THE PREFERRED EMBODIMENTS

Referring to FIGS. 1 and 2, a golf shoe 10 includes an upper 12 and a sole 14 extending from a toe end 16 to a heel end 18 and having a longitudinal length 'l'. Referring to FIG. 3, the sole 14 has a foot bed 20, a mid-sole 22, and an outer sole 24. The foot bed 20 is the top portion of the sole 14 that is adjacent to the wearer's foot. Typically, in use, an inlay sole (not shown) will be placed on top of the foot bed 20. The mid-sole 22 is the portion of the sole sandwiched between the foot bed 20 and the outer sole 24. The mid-sole 22 is a reinforcing longitudinal element and may include a shank (not shown) to provide additional torsional stability to the sole 14.

The outer sole 24 is the bottom portion of the sole 14 that is located below the mid-sole 22 and comes into contact with the ground. The outer sole 24 may have a thickness of between about 0.098 inch (2.5 mm) and about 0.118 inch (3 mm). The outer sole 24 has an outer surface 26 that extends across the bottom of the outer sole 24.

Referring to FIG. 4, the sole 14 is divided into a forefoot 28, which includes a toe area 30 and a ball area 32, a mid-foot area 34, and a heel area 36. The outer sole 24 is substantially flat or horizontal, from the heel area 36 to the ball area 32. The outer sole 24 includes a curvature 38 along the toe area 30.

Referring to FIG. 5, the outer sole 24 includes a first plurality of cleats 40 distributed along the forefoot 28 and a second plurality of cleats 42 distributed along the heel area 36. Each of the plurality of cleats 40, 42 includes a larger sized set of cleats 44 that are substantially encircled by a smaller sized set of cleats 46. The cleats 44, 46 are disposed on the outer surface 26 and extend downward therefrom. In an embodiment shown, the outer sole 24 has thirty-eight (38) of the larger cleats 44 substantially encircled by twenty (20) of the smaller cleats 46 in the ball area 32, and fourteen (14) of

the larger cleats **44** substantially encircled by nine (9) of the smaller cleats **46** in the heel area **36**. The total area of bottom surfaces **56**, shown in FIGS. **6** and **7**, covered by the cleats is approximately 33% of the full outer surface **26** or also referred to as an outsole area. The preferred area coverage of the cleats lies in the range 25% to 40% of the outsole area **26**. Cleat density is defined as a ratio of the number of cleats multiplied by the area of the cleat bottom surface **56** and divided by the full area of the outsole **26** and is important when considering walking comfort. Few large area cleats give poor walking comfort, while many small area cleats give good walking comfort but low grip. A trade off is needed, and the inventors have found that a cleat density equal to or above 0.25 and equal to or below 0.60 gives a good compromise between grip and balanced weight distribution. The preferred range is equal to or above 0.25 and equal to or below 0.40. The number of cleats should be chosen from the range between 40 and 100. In the current embodiment, there are 81 cleats covering approximately $\frac{1}{3}$ of the outsole **26** surface area. This gives a cleat density of approximately 0.33.

Referring to FIGS. **6** and **7**, each cleat **44, 46** has a cross-sectional shape that is essentially cross-shaped. More specifically, the cross-sectional shape is a cross **48** interlaid with and extending from a circle **50** having a center point O. The cross-sectional shape of each cleat **44, 46** may also be described as a circle **50** having two pairs of diametrically opposed cross arms **52, 54** extending radially outward therefrom. The diametrically opposed cross arms **52, 54** are substantially perpendicular to each other. The arms are connected by arc sections **53**, and the number of arc sections **53** corresponds to the number of arms **52, 54**. In this embodiment, four (4) arc sections **53** and four (4) arms **52, 54** are shown. Although there could be a greater or lesser number of arms and arc sections, four arcs and four arms provide superior traction results. The four arc segments are substantially concentric, i.e. they have the same center O, which is the geometrical middle point of the cleat. The arc segments **53** thus have the same radius of curvature $r (=d/2)$, which is smaller than the distance $L (=c/2)$ from the end of a cross arm to the center. The radius r of the arc segments **53** can be decreased and increased; in the most extreme case it can be increased to the radius L corresponding to the length of the arms from their end to the center O. In this case the cleat would simply have the shape of a conical cylinder. Each cleat **44, 46** includes a base portion **55** extending from the outer surface **26** and terminating in a bottom surface **56** which comes into contact with the ground. Each cleat **44, 46** is tapered from the base surface **55** towards the bottom surface **56** such that the cross arm **52** has a larger width at the line where it meets the base surface **55** than at the bottom surface **56**. Preferably, as shown in FIG. **8**, there is a first inclination α of the base surface **55**, and a second, steeper inclination β of the arm **52**. The base surface **55** has the first inclination α of between 15 and 40 degrees with the horizontal plane defined as the outer surface **26**, while the arm **52** has the second inclination β between 60 and 85 degrees with the horizontal plane or outer surface **26**. A fillet radius **58** joins the cross **48** and the circle **50** with the outer surface **26** in the base portion of each cleat **44, 46**. As a result, the cross-section of each cleat **44, 46** decreases from the base portion **55** to the bottom surface **56**. Because the cleat is integrally molded with the outsole, this gives a firm attachment and good stability especially during the golf swing; such firm attachment would not be obtained if the cleat was not integrally molded with the sole, but instead attached via a thread to a receptacle mounted in the sole. The firm grip is further enhanced through the tapering of the cleat.

Each cross arm **52, 54** defines a cross arm length 'c' measured from one end of one of the arms to the other end of the corresponding arm. The cross arm lengths 'c' of each cross arm **52, 54** are substantially equal. The different sets of cleats **44, 46** have different cross arm lengths 'c', as for example 0.276 inch (7 mm) and 0.374 inch (9.5 mm). The different sets of cleats **44, 46** are substantially equally scaled by proportionally enlarging a diameter 'd' of the circle **50** and extending the length of the arms. A ratio of the cross arm length 'c' to the diameter 'd' of the circle **50** for each set of cleats **44, 46** is about 1.6.

The arc segments **53** and the cross arms **52, 54** together define the bottom surface **56**, which is substantially flat, wherein the arc segments and the arms are substantially flush with one another, i.e. there are no protrusions from the bottom surface, such that when the golf shoe is worn outside the golf course, the abrasive wear that would have resulted from such protrusions is minimized.

Referring back to FIG. **5**, one of the diametrically opposed arms **52, 54** is aligned with one of the diametrically opposed arms **52, 54** of an adjacent cleat **44, 46** along transverse rows **60**. Referring to FIG. **9**, the cleats **44, 46** are substantially equally spaced along the transverse rows **60**. The spacing between each of the transverse rows **60** may vary. Some transverse rows **60** may be closer together, having a distance 'a' therebetween, and some transverse rows **60** may be further apart, having a distance 'b' therebetween.

Along the longitudinal length l , each of the cleats **44, 46** is shifted in relation to the preceding and following cleats **44, 46**. As a result, each cleat **44, 46** is perpendicularly offset from an adjacent cleat **44, 46** along the longitudinal length 'l'.

Referring back to FIGS. **7** and **8**, the different sets of cleats **44, 46** also have different heights 'h'. The height of the larger sized cleats **44** is greater than the smaller sized cleats **46**. In one embodiment, the height 'h' of the cleats **44, 46** when measured from the outer surface **26** of the outer sole **24** may be 0.079 inch (2 mm) and 0.118 inch (3 mm), respectively. These heights 'h' could be increased further up to 0.079 inch (2 mm) to improve the grip. However, there is a trade off between having greater height of the cleat to improve grip and possibility of damaging the green.

Referring back to FIG. **5**, the highest cleats **44** are located along the ball area **32** of the forefoot **28** and along the heel area **36**. The ball area **32** and the heel area **36** have cleats **44** with substantially the same height 'h' to provide even distribution across the outer sole **24** of any reaction forces caused by the cleats **44, 46** coming into contact with the ground. The number of cleats **44, 46** is relatively high and the cross arm length 'c' and height 'h' of the cleats **44, 46** is relatively small in comparison to the overall area of the outer surface **26**.

The mid-sole **22** can be fabricated from polyurethane or any other suitable material. In a preferred embodiment, the outer sole **24** is molded from thermoplastic polyurethane (TPU). It is also contemplated that the outer sole **24** may be fabricated from rubber or polyurethane (PU) or any other suitable material.

In operation, the outer sole **24** has a relatively high number of cleats **44, 46** with relatively low heights 'h'. The relatively high number of cleats **44, 46** aids in evenly distributing any reaction forces across the outer sole **24** of the golf shoe **10**. The relatively low heights 'h' of the cleats **44, 46** aid in distributing the weight of the golfer among the cleats **44, 46** and the outer surface **26** to prevent the cleats **44, 46** from excessively digging into a putting green. As the larger cleats **44** disposed in two critical areas of the shoe **10**, the forefoot **28** and heel area **36**, have the same height, there are no "prepressing" zones on the sole. An evenly distributed load across the

5

golf shoe **10** allows the cleats **44, 46** to provide sufficient grip without causing an excessive amount of damage to the putting green.

One advantage of the present invention is that the plurality of cross-shaped cleats **44, 46** allows the golf shoe **10** to achieve a firm grip on a putting green. The cross-shaped cleats **44, 46** counteract a twisting torque exerted on the sole **14** during a golf swing. A large number of cross-shaped cleats **44, 46** with a relatively small height 'h' gives the golf shoe **10** an improved grip.

Another advantage of the present invention is that the outer sole **24** has no sharp internal corners or edges. The circle **50** connects the cross arms **52, 54** of the cross **48** to aid in sparing the putting green from damage by eliminating sharp internal corners or edges. The elimination of sharp internal corners also minimizes collecting mud and grass on the shoe **10** during use.

A further advantage is that the golf shoe **10** can be used as a casual shoe. The shape, size, and location of the cleats **44, 46** eliminate the need for changing into other shoes before or after a round of golf. The cleats **44, 46** act together to distribute the load evenly across the outer sole **24** and into the foot to make walking on normal streets and other surfaces possible. The golf shoe **10** can be comfortably used outside the green, as for example while driving a car.

Although the invention has been shown and described with respect to exemplary embodiments thereof, it should be understood by those skilled in the art that various changes, omissions, and additions may be made thereto, without departing from the spirit and scope of the invention. For example, although specific dimensions have been disclosed, the cross arm length 'c' and the height 'h' may be greater or less than the specific dimensions disclosed. Further, each of the larger and smaller sets of cleats **44, 46** may include more or less than the number disclosed above in each of the forefoot and heel area and in varying configurations.

What is claimed is:

1. A golf shoe having a sole comprising:

an outer surface having a longitudinal length extending from a toe end to a heel end of the sole;

a plurality of cleats integrally molded with the outer surface and extending outwardly therefrom, the plurality of cleats distributed along at least a forefoot and a heel area of the sole;

wherein the plurality of integrally molded cleats includes a first set of cleats having a larger size and a second set of cleats having a smaller size;

wherein the integrally molded cleats are arranged in transverse rows along the longitudinal length of sole, the transverse rows being parallel to one another and perpendicular to the longitudinal length; and

wherein all of the cleats of at least one transverse row of integrally molded cleats in the heel area have smaller heights than all of the cleats of at least one other transverse row of integrally molded cleats in the heel area.

2. The golf shoe according to claim 1, wherein the cleats are tapered in a direction from a bottom surface towards a base surface such that the cleats form conical cylinders.

3. The golf shoe according to claim 2, wherein the cleats have a tapering of between 60 and 85 degrees with a horizontal plane.

4. The golf shoe according to claim 2, wherein a total area of the bottom surfaces of the cleats compared to an area of the outer surface is within the range of about 25% to about 40%.

5. The golf shoe according to claim 1, wherein the cleats having the smaller size substantially encircle the cleats having the larger size.

6

6. The golf shoe according to claim 1, wherein the forefoot of the sole has more cleats than the heel area of the sole.

7. The golf shoe according to claim 1, wherein at least one cleat is offset from an adjacent cleat along the longitudinal length.

8. The golf shoe according to claim 1, wherein the cleats of the larger sized set of cleats have greater heights than the cleats of the smaller sized set of cleats.

9. The golf shoe according to claim 1, wherein the forefoot includes a ball area and a toe area, the ball area and the heel area having cleats that are substantially equal in height.

10. The golf shoe according to claim 1, wherein the sole has a thickness of about 0.098 inch to about 0.118 inch.

11. The golf shoe according to claim 1, wherein the sole is constructed from a material selected from the group consisting of thermoplastic polyurethane and polyurethane and rubber.

12. The golf shoe according to claim 1, wherein the cleats of the plurality of cleats extend from the outer surface at heights selected from the group consisting of 0.079, 0.118, and 0.197 inch.

13. The golf shoe according to claim 1, wherein each cleat of the plurality of cleats has the shape of a conical cylinder.

14. The golf shoe according to claim 1, wherein a cleat density of the sole is between about 0.25 and 0.60.

15. A golf shoe having a sole comprising:

an outer surface extending over a toe area, a ball area, a mid-foot area, and a heel area, the outer surface having a longitudinal length extending from a toe end to a heel end of the sole;

a first plurality of cleats integrally molded with the outer surface and extending outwardly therefrom in the heel area;

a second plurality of cleats integrally molded with the outer surface and extending outwardly therefrom in the toe area and the ball area;

wherein the integrally molded cleats of the first plurality of cleats and the second plurality of cleats are conical cylinders;

wherein the integrally molded cleats of the first plurality of cleats are arranged in transverse rows along the longitudinal length of the sole, the transverse rows being parallel to one another and perpendicular to the longitudinal length; and

wherein all of the cleats of at least one transverse row of integrally molded cleats in the heel area have smaller heights than all of the cleats of at least one other transverse row of integrally molded cleats in the heel area.

16. The golf shoe according to claim 15, wherein the cleats are substantially equally spaced along the transverse rows.

17. The golf shoe according to claim 15, wherein at least one cleat is perpendicularly offset from an adjacent cleat along the longitudinal length.

18. A golf shoe comprising:

a sole having an outer surface having a longitudinal length extending from a toe end to a heel end of the sole;

a plurality of cleats that are integrally molded with the outer surface and extending outwardly therefrom, the plurality of cleats distributed along at least a forefoot and a heel area of the sole;

wherein the integrally molded cleats are tapered in a direction from a bottom surface towards a base surface such that the cleats form conical cylinders; and

wherein the integrally molded cleats are arranged in transverse rows along the longitudinal length of the sole, the transverse rows being parallel to one another and perpendicular to the longitudinal length, wherein all of the

cleats of at least one transverse row of integrally molded cleats in the heel area have smaller heights than all of the cleats of at least one other transverse row of integrally molded cleats in the heel area.

19. The golf shoe according to claim **18**, wherein the cleats have a tapering of between 60 and 85 degrees with a horizontal plane.

* * * * *